

STANDARD: 80013317

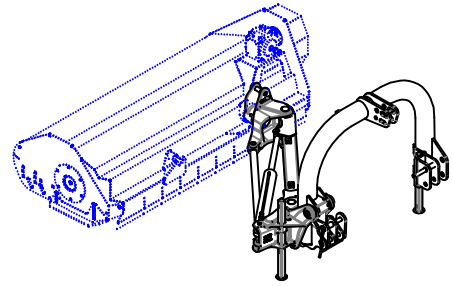

HYDRAULIC SIDE ADJUSTMENT

STANDARD PROF: 80012284R

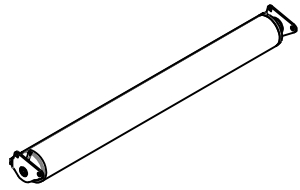

BACK ROLLER WITH INTERCHANGEABLE CENTRAL PART

STANDARD: 00021942

OPTIONAL: 00021944

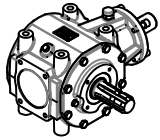

540 rpm.

30040478



540 rpm.

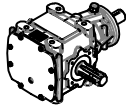

130 HP

OPTIONAL: 80013570

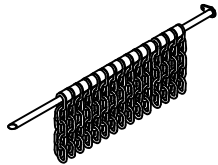

PROTECTION CHAIN

OPTIONAL: 80013491

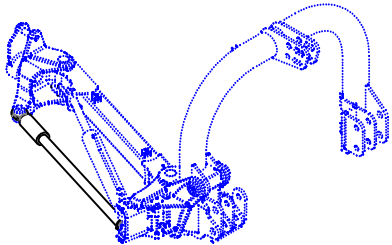

OLEOPNEUMATIC ANTI-SHOCK DEVICE

OPTIONAL: 80012426

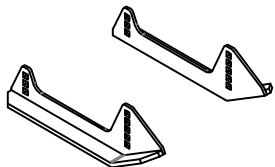

SKIDS

STANDARD: 00017673

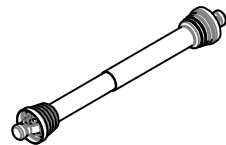

DOUBLE HOMOKINETIC CARDAN

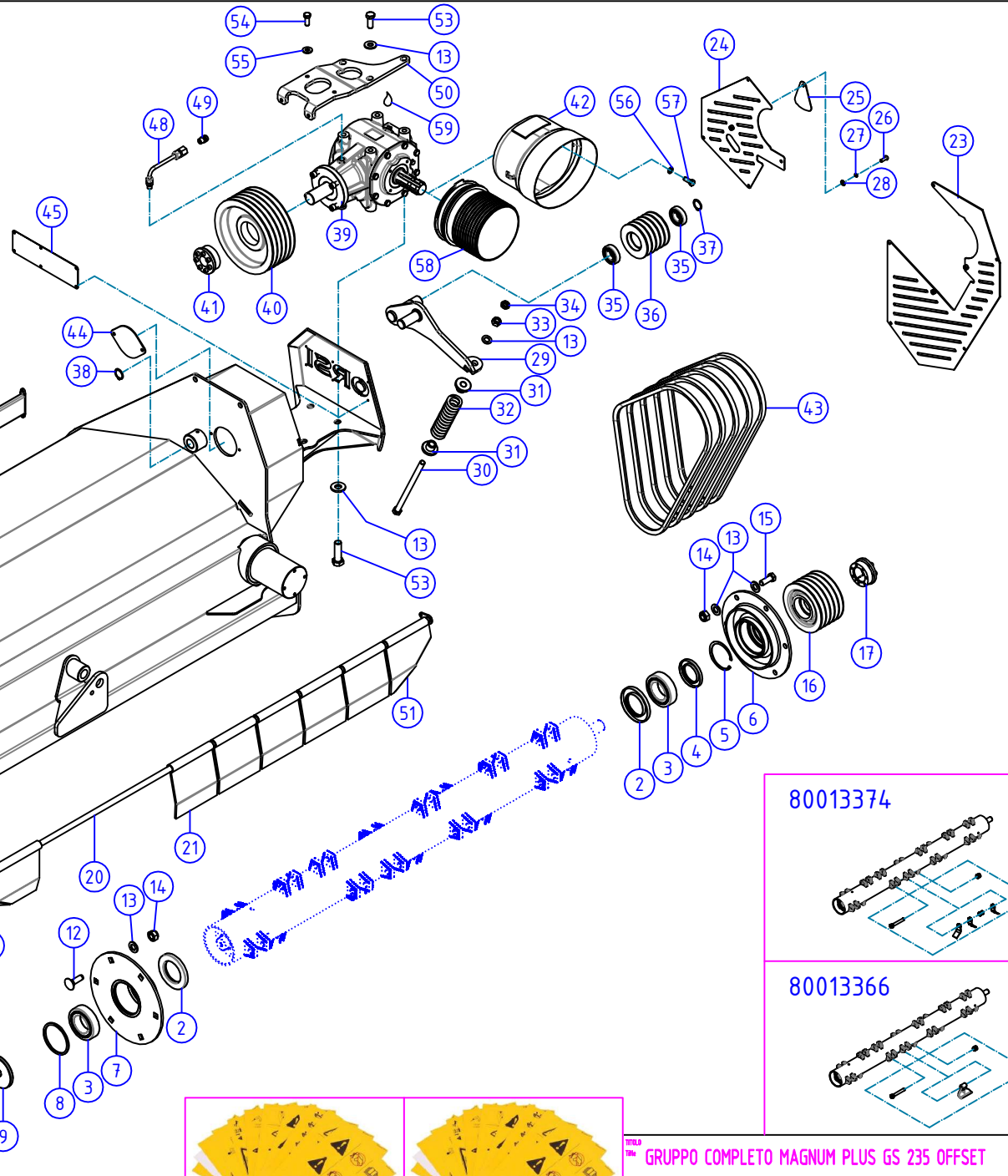

80013374

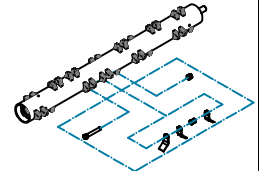

80013366

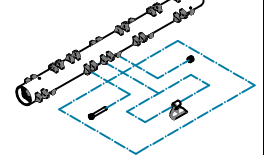

00021867



00033011
AGROMECC

TITolo GRUPPO COMPLETO MAGNUM PLUS GS 235 OFFSET

CODICE 80013344

REV 2

DATA date 16/05/2019



Codice / Code	80013344	GRUPPO COMPLETO MAGNUM PLUS 235 OFFSET
Data / Date	16/05/2019	Pagina / Page 1

Nr.	Codice Code	Descrizione Part	Quantità Quantity
1	30039908	CASSA MAGNUM PLUS 235 OFFSET	1,00000
2	00012040	PARAOLIO 75x120x12	2,00000
3	00011003	CUSCINETTO 22212 C W33	2,00000
4	00012043	PARAOLIO 60x95x10	1,00000
5	10200950	SEEGER I 95 U7437 NOR	1,00000
6	30026422	FLANGIA LATO PULEGGE WPO	1,00000
7	30034069	FLANGIA LATO RINVIO UNIQUE/CHAMPION / WGR	1,00000
8	30025861	SPESSORE 5MM. LATO RINVIO	1,00000
9	30024190	COPERCHIETTO FLANGIA RINVIO	1,00000
10	00011505	GUARNIZIONE OR 189	1,00000
11	10201100	SEEGER I110 U7437 NOR	1,00000
12	11216101	VITE UNI 5731 M16X40 8.8 ZIN.	6,00000
13	11160000	ROS.PIANA D.16 U6592 ZIN	23,00000
14	10114161	DA BASS.M 16 U7474 FE ZIN	12,00000
15	11116101	VTE 16X 40 U5739 8.8 ZIN	6,00000
16	00018537	PULEGGIA 5 G.SPB D.180 F.80	1,00000
17	00018023	CALETTATORE D. 50X 80 N°7 VITI M8X25	1,00000
19	30039858	BANDELLA POST. MAGNUM PLUS 235	1,00000
20	30034387	ASTA PORTA BANDELLA UNIQUE-PRESTIGE LEFT 2300	1,00000
21	30037756	BANDELLA L.200 PRIMATIST PLUS	9,00000
23	30040368	ASSIEME CARTER MAGNUM PLUS OFFSET	1,00000
24	30040369	ASSIEME CARTERINO MAGNUM PLUS OFFSET	1,00000
25	01014495	CHIUSURA ASOLA CARTER CINGHIE	1,00000
26	11908071	VTBE 8X 25 I7380 10.9 ZIN	1,00000
27	12080000	ROS.GROW. D. 8 U1751 RINF.ZIN	1,00000
28	11080000	ROS.PIANA D. 8 U6592 ZIN	1,00000
29	30040366	REGISTRO GALOPPINO MAGNUM PLUS OFFSET	1,00000
30	30040913	TIRANTE FILETTATO PER TENDICINGHIA L.340	1,00000
31	30027524	RONDELLA GUIDA MOLLA WGR	2,00000
32	30000860	MOLLA AMMORTIZZATORE SERIE AGRI ZINCATA	1,00000
33	10125164	DE NORM M 16 U5588 FE ZIN	1,00000
34	10115161	DE BASS.M 16 U5589 ZIN	1,00000
35	00011083	CUSCINETTO 2207 E 2RS 35.72.23 (SKF)	2,00000
36	30035721	PULEGGIA GALOPPINO 5 GOLE DP 160	1,00000
37	10100350	SEEGER E 35 U7435 NOR	1,00000
38	10100300	SEEGER E 30 U7435 NOR	1,00000
39	00021942	SCATOLA T-290A R=1:3 MONTAGGIO OFF-SET	1,00000
40	00018543	PULEGGIA 5 G.SPB D.250 F.80 FORMA C1	1,00000
41	00018018	CALETTATORE D. 40 x 80	1,00000
42	00019527	CONTROCUFFIA OVALE 230x280 H=230 FORATA (Vale fino 31/08/2019)	1,00000
43	00010523	CINGHIA QPIII XPB 1600/5VX 634 (GATES)	5,00000



Nr.	Codice Code	Descrizione Part	Quantità Quantity
44	01017389	COPERCHIETTO SP. 3 IN FE 360	1,00000
45	01017376	LAMIERINO DIETRO LOGO	1,00000
48	30038692	TUBINO SFIATO 3/8"	1,00000
49	00014352	SFIATO PER SCATOLA INGRANAGGI 3/8"	1,00000
50	30040585	SUPPORTO PIEGATO SP. 12 IN FE 360	1,00000
51	30040374	BANDELLA L.200 GS	1,00000
52	30040378	BANDELLA L.127/174 GS	1,00000
53	11116091	VTE 16X 35 U5739 8.8 ZIN	7,00000
54	11106051	VTE 12X 20 U5739 8.8 ZIN	2,00000
55	11120000	ROS.PIANA D.12 U6592 ZIN	2,00000
56	11080000	ROS.PIANA D. 8 U6592 ZIN	4,00000
57	11108041	VTE 8X 16 U5739 8.8 ZIN	4,00000
58	00019530	CONTROCUFFIA WALTERSCHEID D.250 L=240 (Vale da 01/09/2019)	1,00000
59	01000006	OLIO SPARTAN EP 150	2,00000